Atomic & Nuclear Physics

AP Physics B

Life and Atoms

Every time you breathe you are taking in atoms. Oxygen atoms to be exact. These atoms react with the blood and are carried to every cell in your body for various reactions you need to survive. Likewise, every time you breathe out carbon dioxide atoms are released.

The cycle here is interesting.

**TAKING SOMETHING IN.
ALLOWING SOMETHING OUT!**

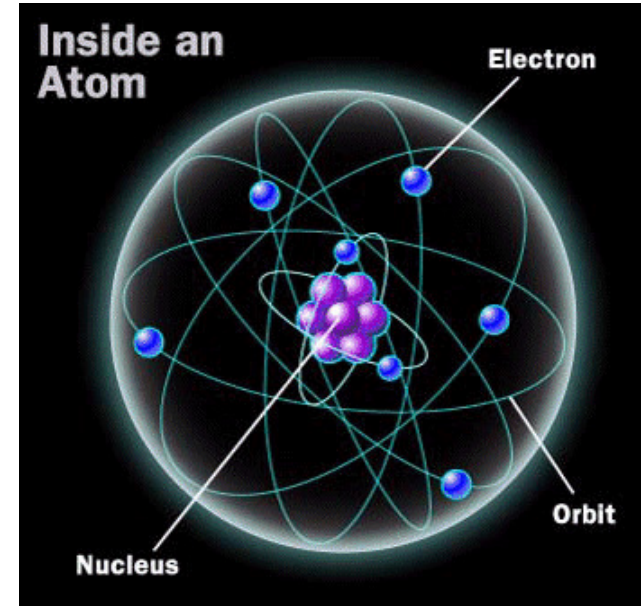

The Atom

As you probably already know an atom is the building block of all matter. It has a nucleus with protons and neutrons and an electron cloud outside of the nucleus where electrons are orbiting and MOVING.

Depending on the ELEMENT, the amount of electrons differs as well as the amounts of orbits surrounding the atom.

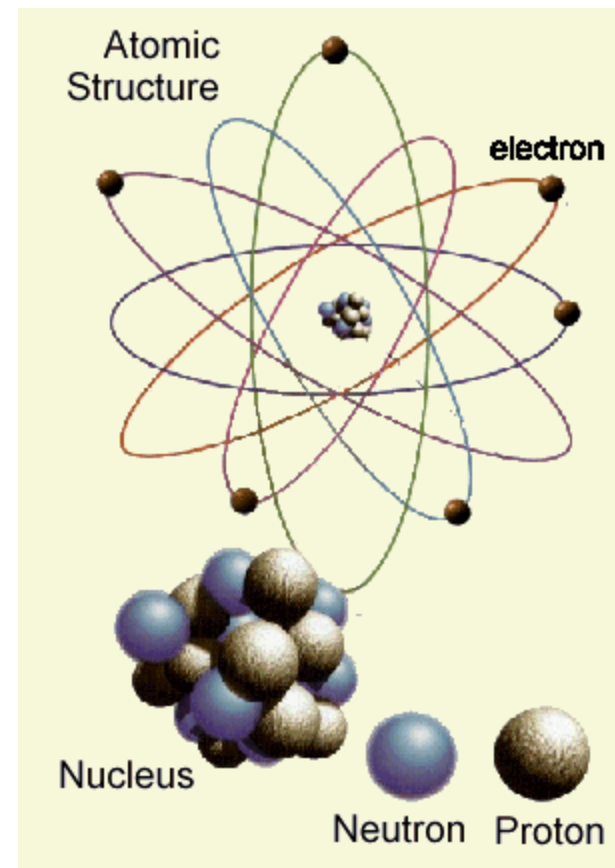

When the atom gets excited or NOT

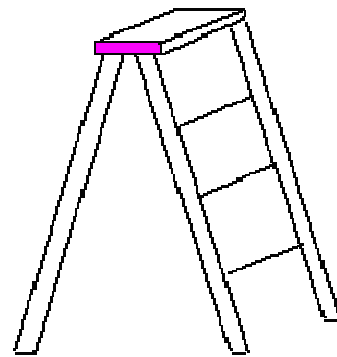

Nucleus

← 5
← 4
← 3
← 2
← n=1

Rungs
correspond
to energy
levels.

n=1 is the lowest
energy level.

To help visualize the atom think of it like a ladder. The bottom of the ladder is called **GROUND STATE** where all electrons would like to exist. If energy is **ABSORBED** it moves to a new rung on the ladder or **ENERGY LEVEL** called an **EXCITED STATE**. This state is **AWAY** from the nucleus.

As energy is **RELEASED** the electron can relax by moving to a new energy level or rung down the ladder.

Energy Levels

Yet something interesting happens as the electron travels from energy level to energy level.

If an electron is **EXCITED**, that means energy is **ABSORBED** and therefore a **PHOTON** is absorbed.

If an electron is **DE-EXCITED**, that means energy is **RELEASED** and therefore a photon is released.

We call these leaps from energy level to energy level **QUANTUM LEAPS**.

Since a **PHOTON** is emitted that means that it **MUST** have a certain wavelength.

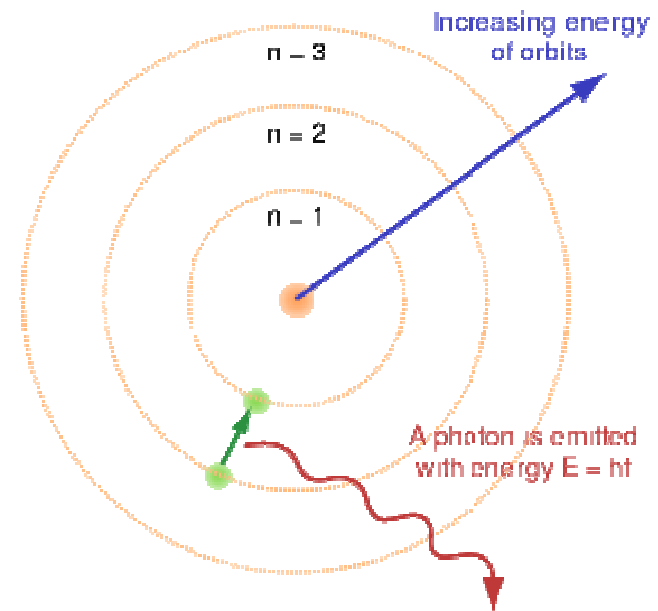
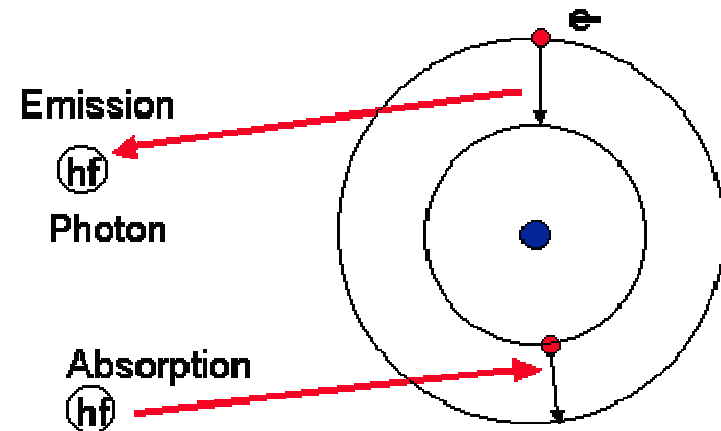

Energy of the Photon

We can calculate the **ENERGY** of the released or absorbed photon provided we know the initial and final state of the electron that jumps energy levels.

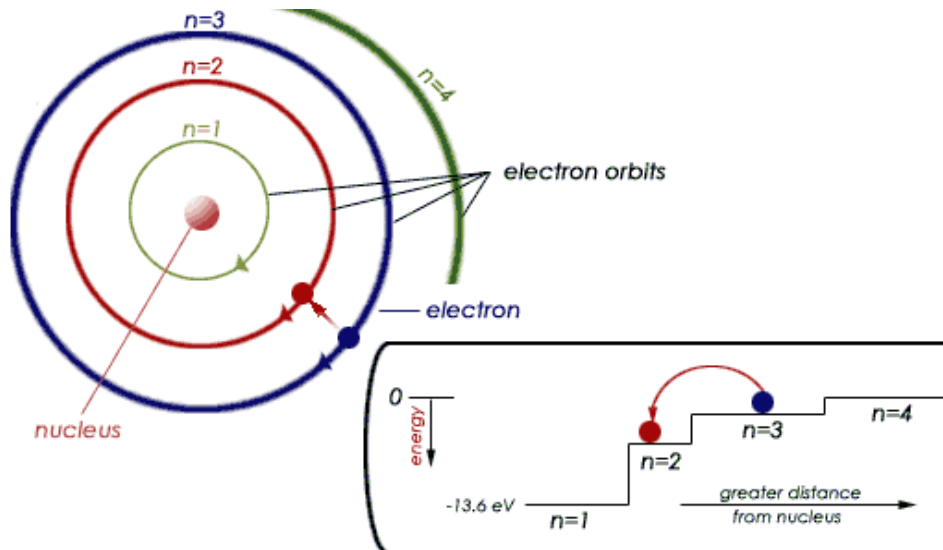
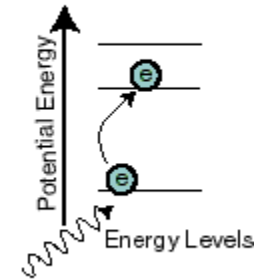
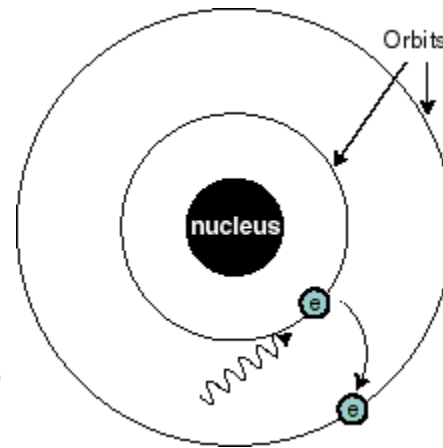

$$\Delta E = hf = \frac{hc}{\lambda}$$

Energy Level Diagrams

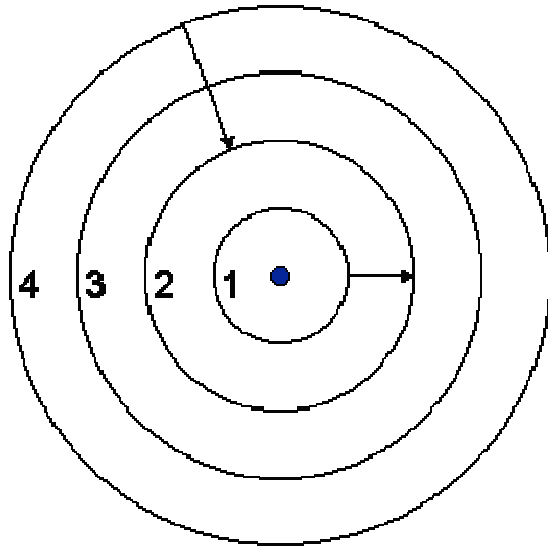

Energy Level Diagram

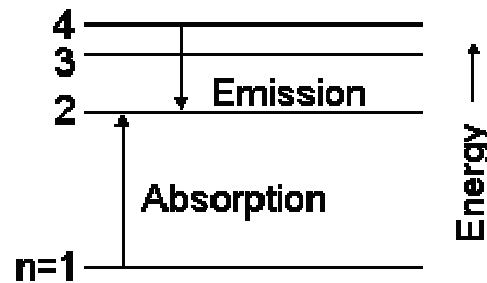

A schematic representation of the orbital energy levels.

To represent these transitions we can construct an **ENERGY LEVEL DIAGRAM**

Note: It is very important to understanding that these transitions DO NOT have to occur as a single jump! It might make TWO JUMPS to get back to ground state. If that is the case, TWO photons will be emitted, each with a different wavelength and energy.

Example

An electron releases energy as it moves back to its ground state position. As a result, photons are emitted. Calculate the POSSIBLE wavelengths of the emitted photons.

$$\Delta E = hf = \frac{hc}{\lambda}$$

Notice that they give us the energy of each energy level. This will allow us to calculate the CHANGE in ENERGY that goes to the emitted photon.

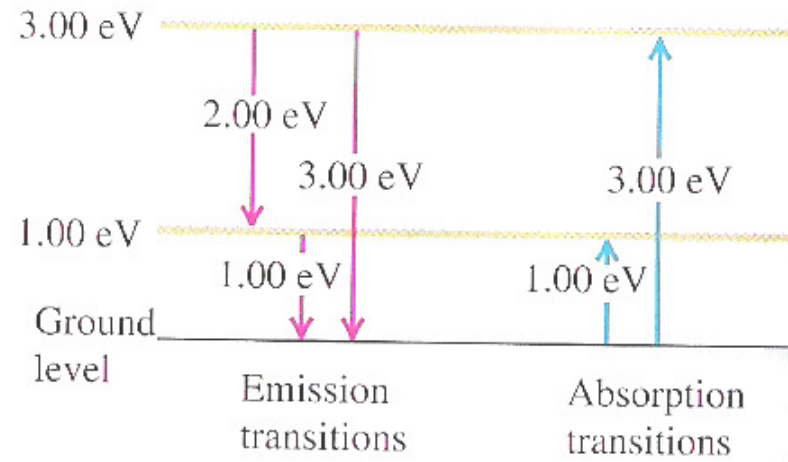

$$\lambda = \frac{hc}{\Delta E} = \frac{1240 \text{ eV} \cdot \text{nm}}{3 \text{ eV}} = 413 \text{ nm}$$

$$\lambda = \frac{hc}{\Delta E} = \frac{1240 \text{ eV} \cdot \text{nm}}{2 \text{ eV}} = 620 \text{ nm}$$

$$\lambda = \frac{hc}{\Delta E} = \frac{1240 \text{ eV} \cdot \text{nm}}{1 \text{ eV}} = 1240 \text{ nm}$$

This particular sample will release three different wavelengths, with TWO being the visible range (RED, VIOLET) and ONE being OUTSIDE the visible range (INFRARED)

Energy levels Application: Spectroscopy

Spectroscopy is an optical technique by which we can IDENTIFY a material based on its emission spectrum. It is heavily used in Astronomy and Remote Sensing. There are too many subcategories to mention here but the one you are probably the most familiar with are flame tests.

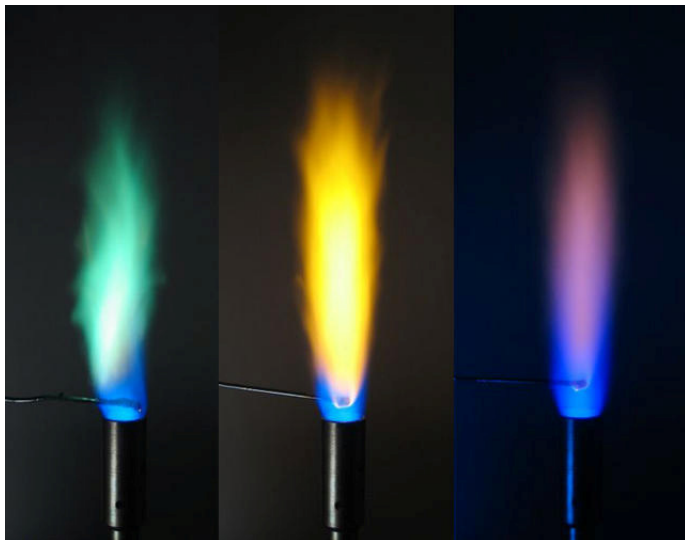

When an electron gets excited inside a SPECIFIC ELEMENT, the electron releases a photon. This photon's wavelength corresponds to the energy level jump and can be used to indentify the element.

Different Elements = Different Emission Lines

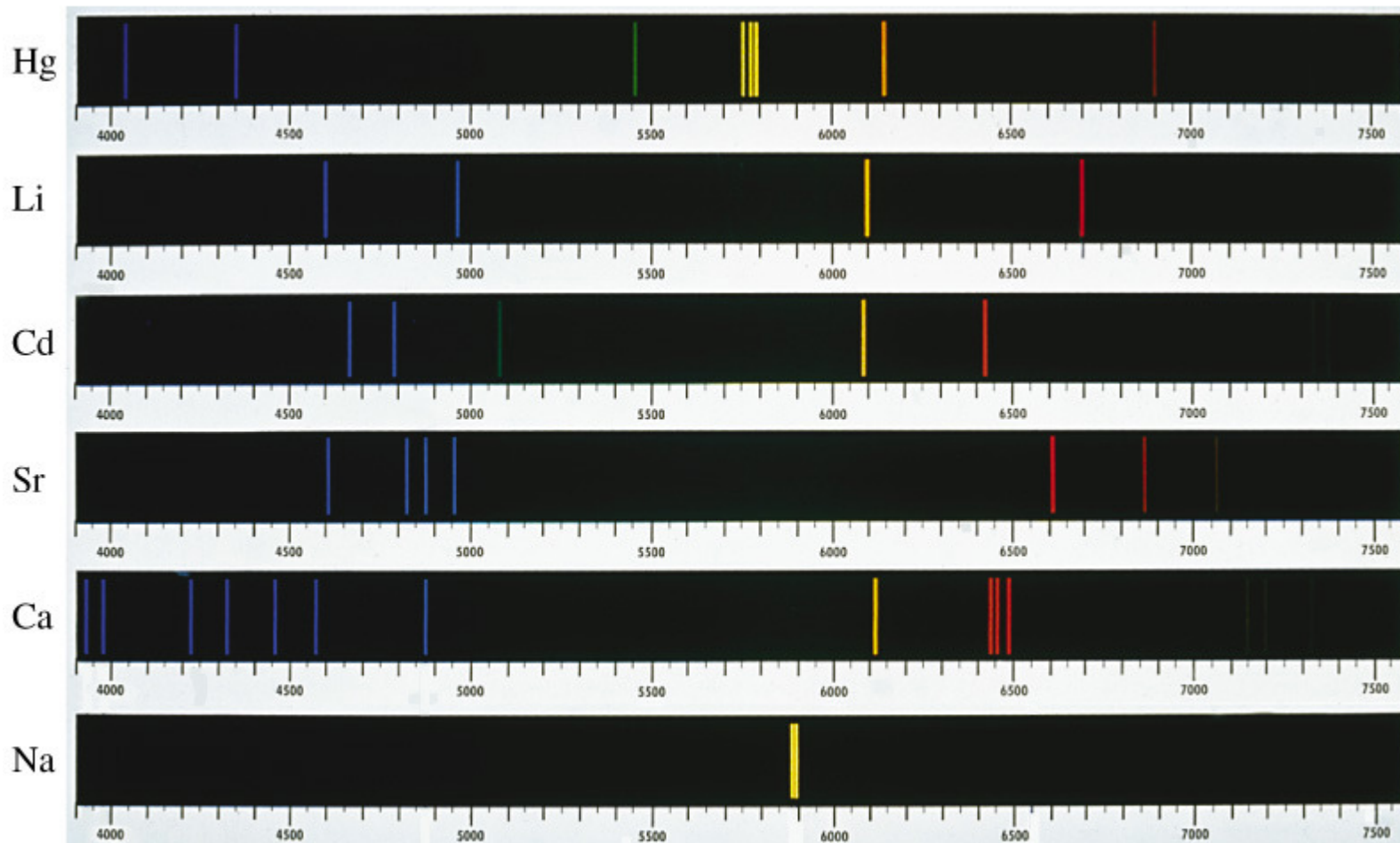

Emission Line Spectra

So basically you could look at light from any element of which the electrons emit photons. If you look at the light with a diffraction grating the lines will appear as sharp spectral lines occurring at specific energies and specific wavelengths. This phenomenon allows us to analyze the atmosphere of planets or galaxies simply by looking at the light being emitted from them.

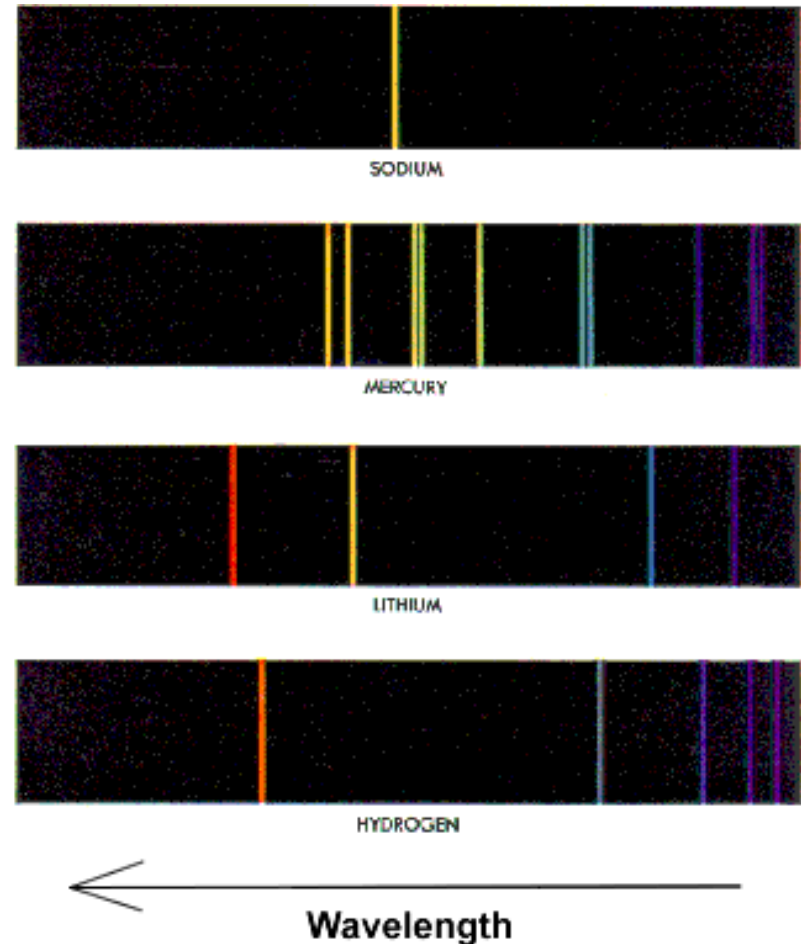

Nuclear Physics - Radioactivity

Before we begin to discuss the specifics of radioactive decay we need to be certain you understand the proper **NOTATION** that is used.

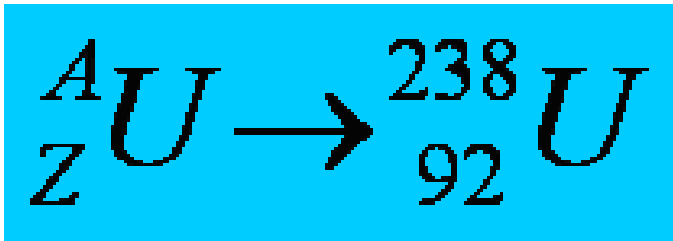

To the left is your typical radioactive isotope.

Top number = mass number = #protons + neutrons. It is represented by the letter "A"

Bottom number = atomic number = # of protons in the nucleus. It is represented by the letter "Z"

Nuclear Physics – Notation & Isotopes

An isotope is when you have the **SAME ELEMENT**, yet it has a **different MASS**.

This is a result of have extra neutrons. Since Carbon is always going to be element #6, we can write Carbon in terms of its mass instead.

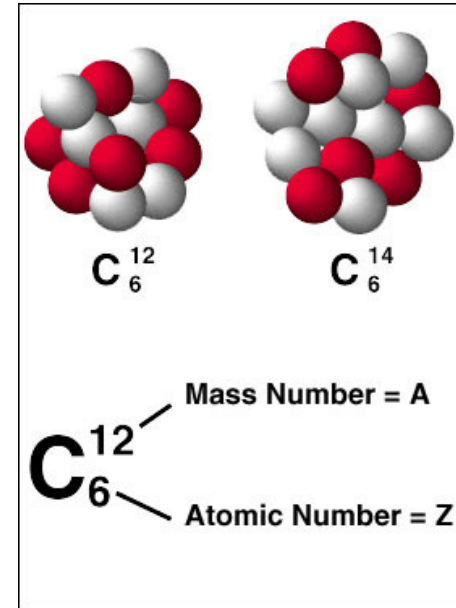

Carbon - 12

Carbon - 14

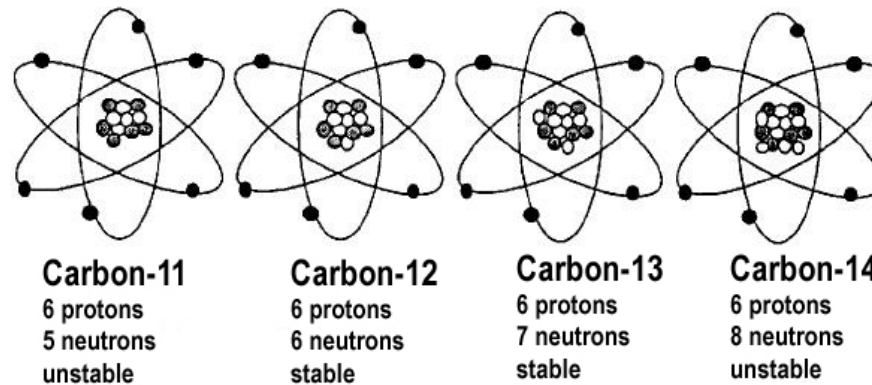

Einstein – Energy/Mass Equivalence

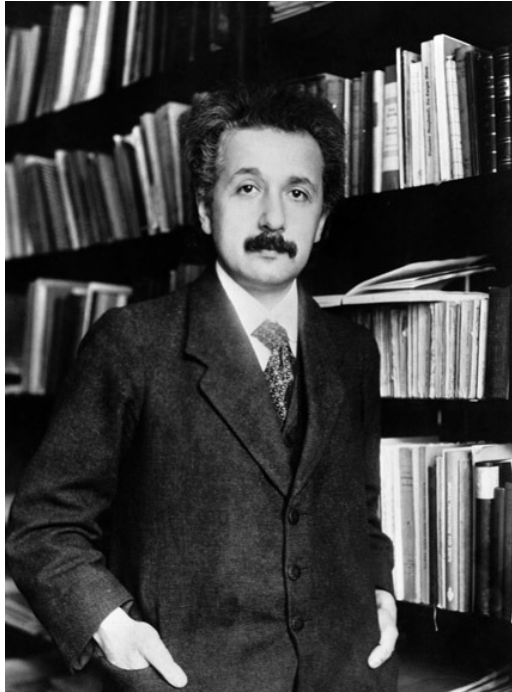

In 1905, Albert Einstein publishes a 2nd major theory called the **Energy-Mass Equivalence** in a paper called, “Does the inertia of a body depend on its energy content?”

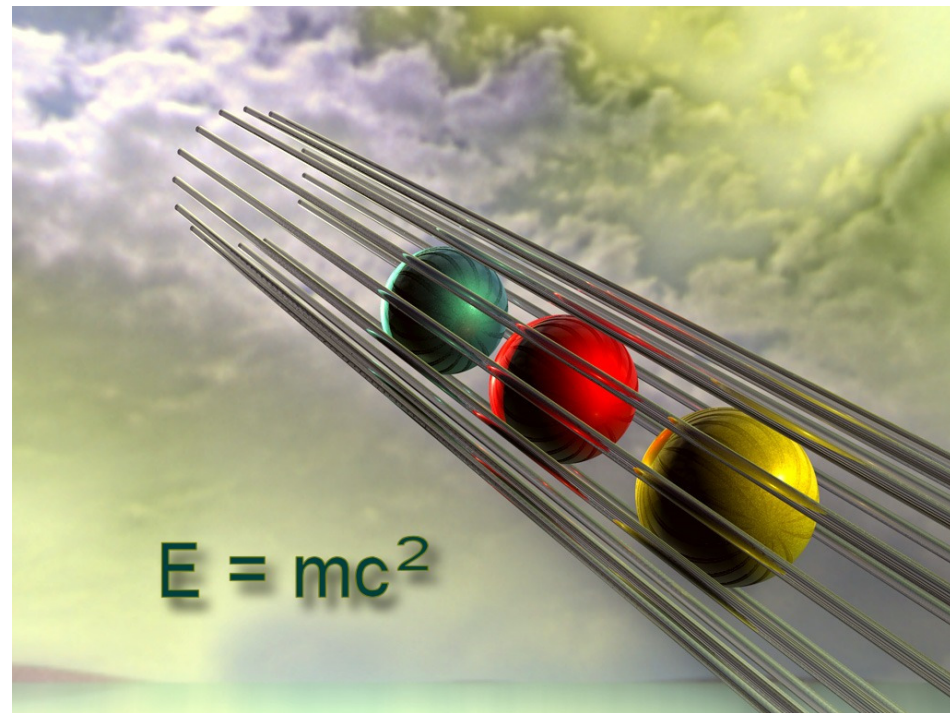

Einstein – Energy/Mass Equivalence

Looking closely at Einstein's equation we see that he postulated that mass held an enormous amount of energy within itself. We call this energy **BINDING ENERGY** or Rest mass energy as it is the energy that holds the atom together when it is at rest. The large amount of energy comes from the fact that the speed of light is squared.



Energy Unit Check

$$E_B = \Delta mc^2 \rightarrow \text{Joule} = \text{kg} \times \frac{\text{m}^2}{\text{s}^2}$$

$$W = Fx \rightarrow \text{Joule} = \text{Nm}$$

$$F_{\text{net}} = ma \rightarrow \text{N} = \text{kg} \times \frac{\text{m}}{\text{s}^2}$$

$$E = W = \text{kg} \times \frac{\text{m}}{\text{s}^2} \times \text{m} = \text{kg} \times \frac{\text{m}^2}{\text{s}^2}$$

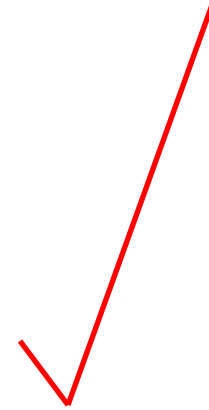

Mass Defect

$$E_B = \Delta mc^2$$

E_B = Binding energy

Δm = mass defect

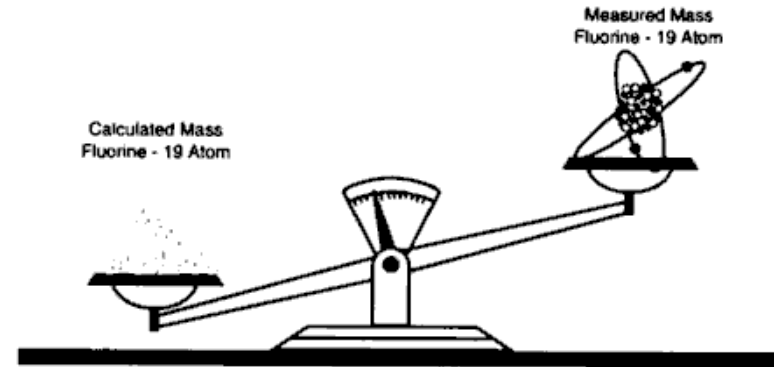

Figure 2-V. Illustration of a Mass Defect

The nucleus of the atom is held together by a **STRONG NUCLEAR FORCE**.



The more stable the nucleus, the more energy needed to break it apart. Energy needed to break the nucleus into protons and neutrons is called the **Binding Energy**

Einstein discovered that the mass of the separated particles is greater than the mass of the intact stable nucleus to begin with.

This difference in mass (Δm) is called the **mass defect**.

Mass Defect - Explained

- ❖ mass number \neq isotope mass \neq mass of separate nucleons!
- ❖ example: carbon-12

| | | |
|---|---|---|
|  mass number 12 | 6 p⁺ @ 1.007276 amu each 6 n @ 1.008665 amu each mass of separate nucleons 12.095646 amu |  isotope mass 11.996709 amu |
|---|---|---|

mass defect: 0.098937 amu

$$u = 1.660559 \times 10^{-27} \text{ kg}$$

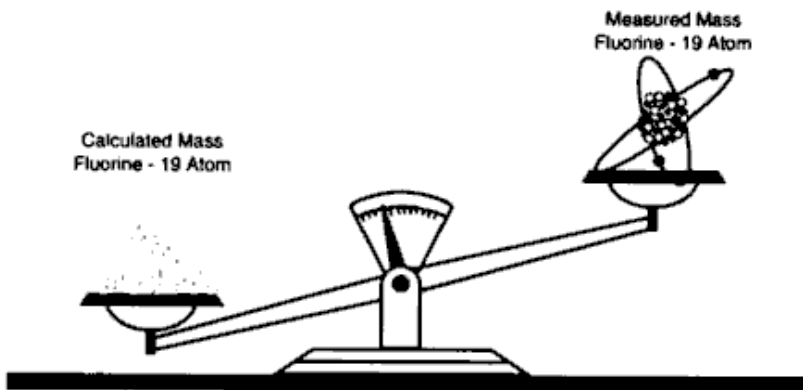
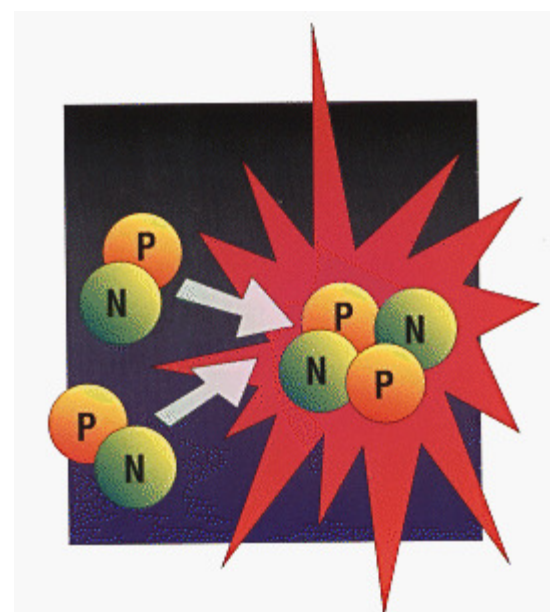

Figure 2-V. Illustration of a Mass Defect



The extra mass turns into energy holding the atom together.

Mass Defect – Example

$$1 u = 1.660559 \times 10^{-27} \text{ kg}$$

| Particle | Mass(kg) | u |
|----------|--------------------------|------------------------|
| Proton | 1.6726×10^{-27} | 1.007276 |
| Neutron | 1.6750×10^{-27} | 1.008665 |
| Electron | 9.109×10^{-31} | 5.486×10^{-4} |

Calculation of the Mass Defect for He 4

(The atom has less mass than the individual parts)

Mass of the individual parts

- p^+ 1.007277 amu
- p^+ 1.007277 amu
- n 1.008665 amu
- n 1.008665 amu

4.03190 amu

Mass of the Helium nucleus



4.00150 amu

mass defect = the loss of mass in atomic mass units
 mass defect = 4.03190 amu - 4.00150 amu
 mass defect = 0.03040 amu

The mass that is lost, is converted into energy. This energy is the nuclear energy that binds the nucleus of an atom together

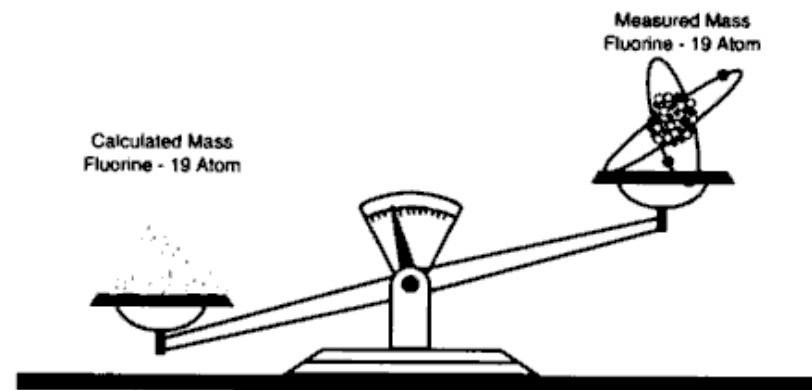

$$E_B = \Delta mc^2$$

E_B = Binding energy

Δm = mass defect

Radioactivity

When an unstable nucleus releases energy and/or particles.

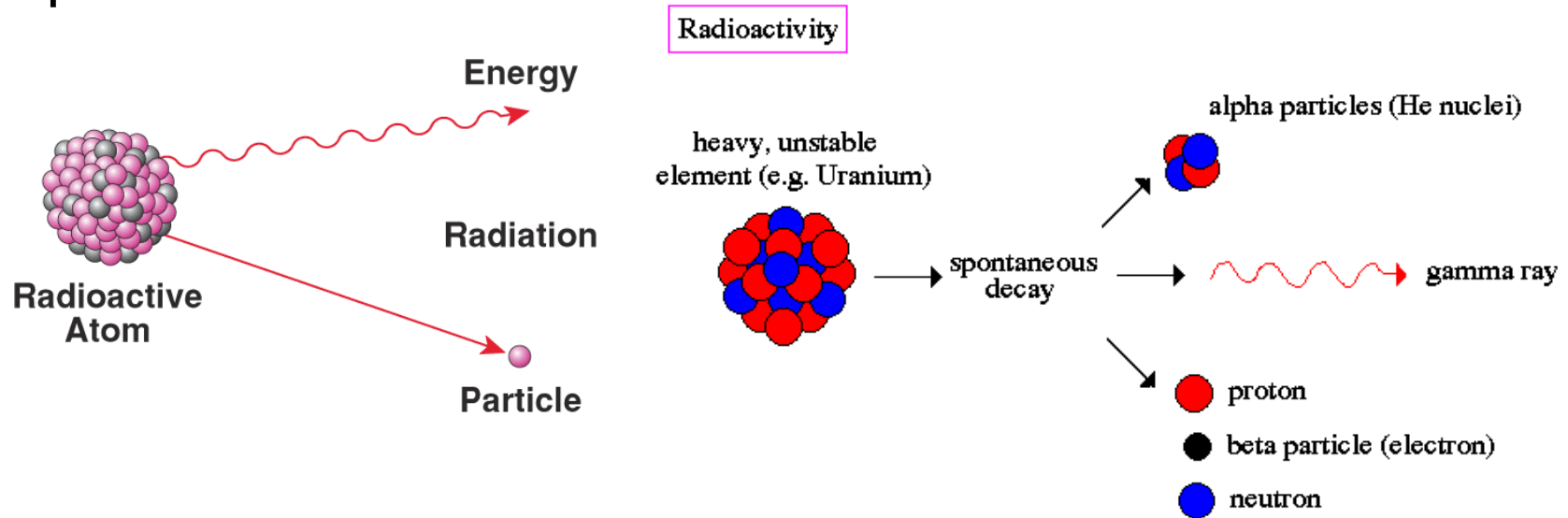

Radioactive Decay

There are 4 basic types of radioactive decay

- Alpha – Ejected Helium
- Beta – Ejected Electron
- Positron – Ejected Anti-Beta particle
- Gamma – Ejected Energy

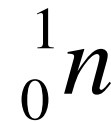
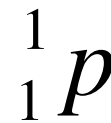
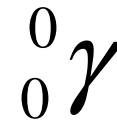
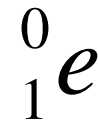
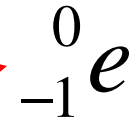
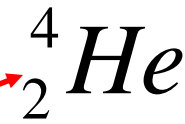

You may encounter protons and neutrons being emitted as well

Alpha Decay

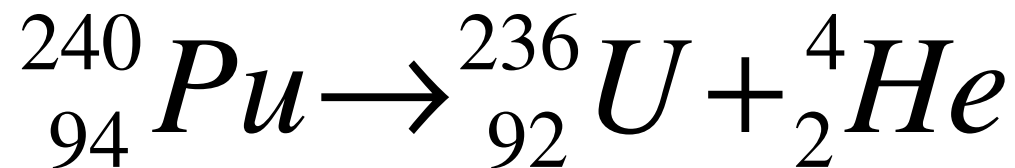
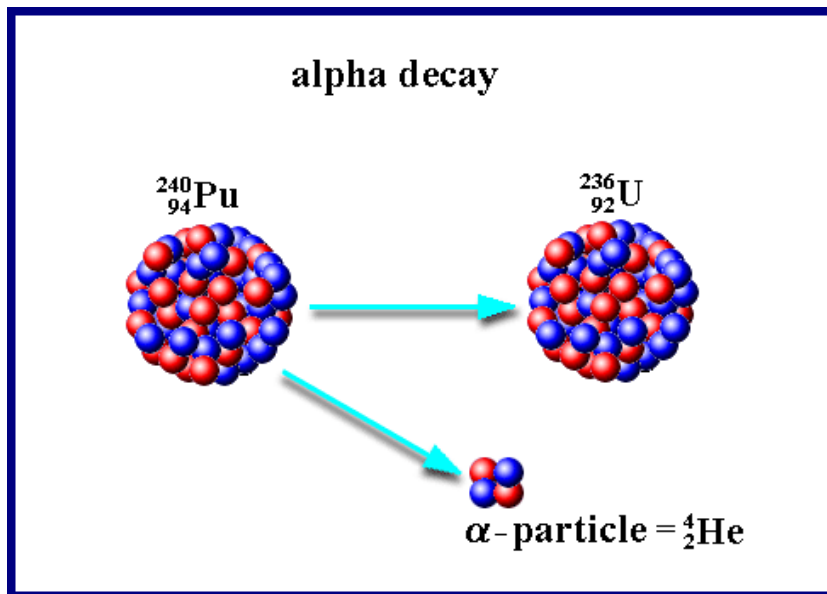
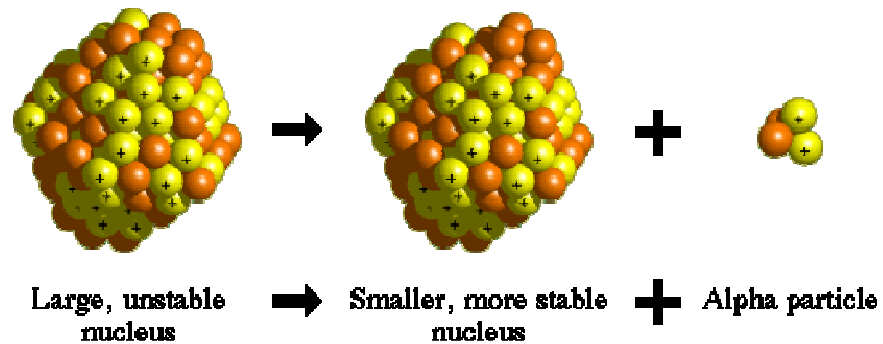

Alpha Decay Applications

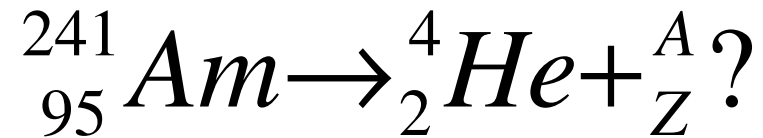

Americium-241, an alpha-emitter, is used in smoke detectors. The alpha particles ionize air between a small gap. A small current is passed through that ionized air. Smoke particles from fire that enter the air gap reduce the current flow, sounding the alarm.

Beta Decay

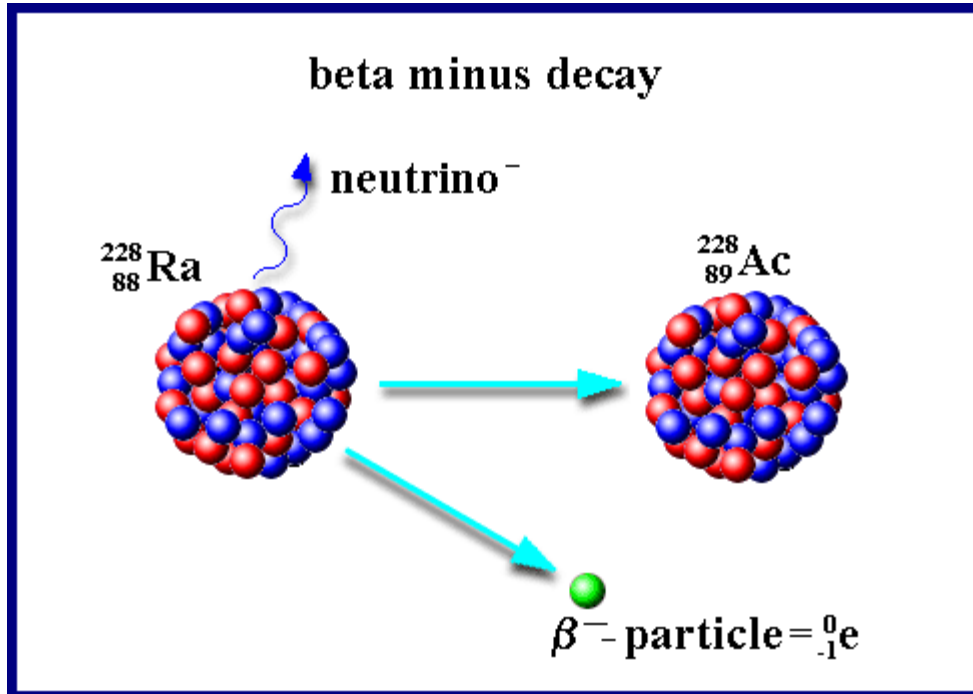

There aren't really any applications of beta decay other than Betavoltaics which makes batteries from beta emitters. Beta decay, did however, lead us to discover the neutrino.

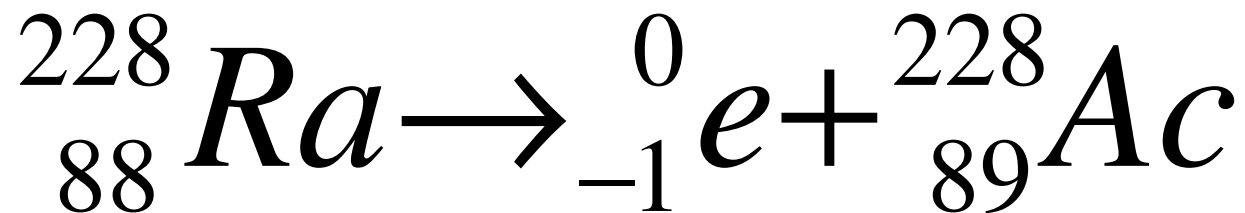

Beta Plus Decay - Positron

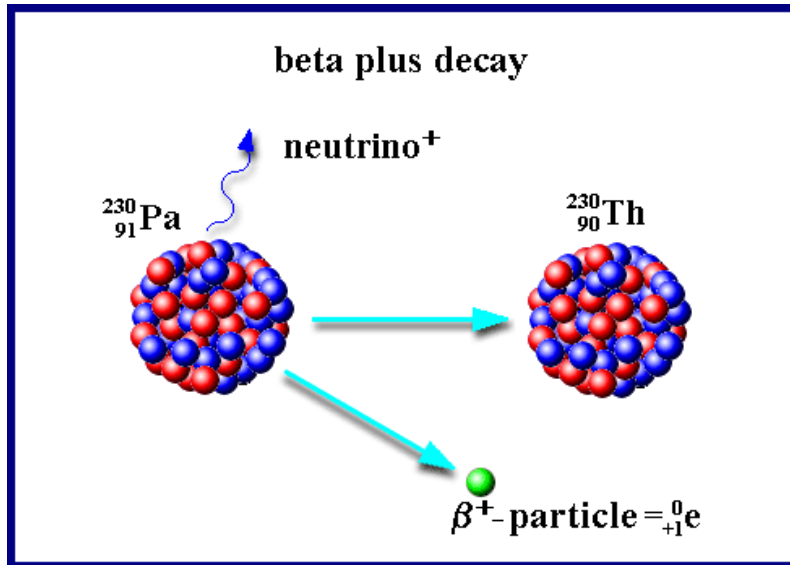

Isotopes which undergo this decay and thereby emit positrons include carbon-11, potassium-40, nitrogen-13, oxygen-15, fluorine-18, and iodine-121.

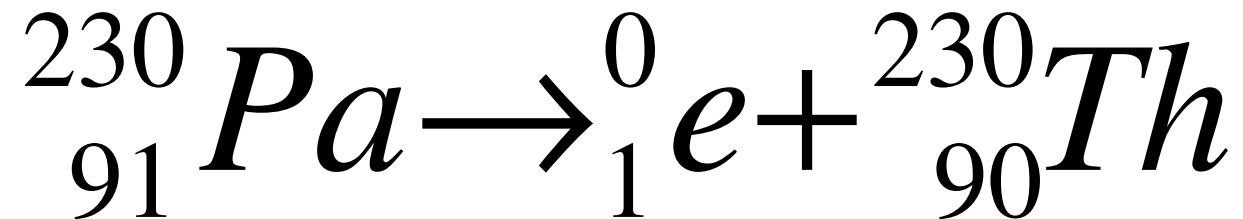

Beta Plus Decay Application - **Positron emission tomography (PET)**

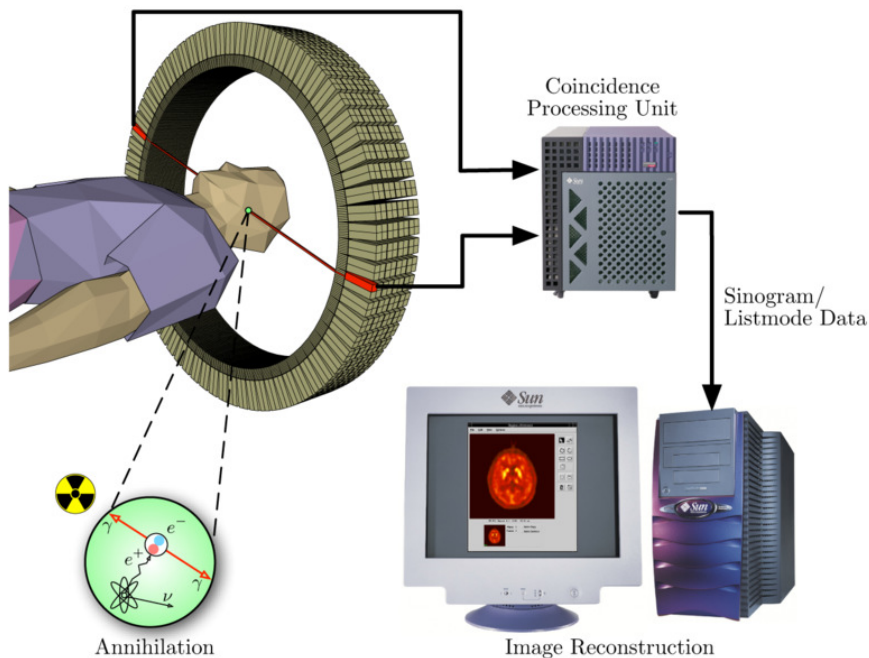

Positron emission tomography (PET) is a nuclear medicine imaging technique which produces a three-dimensional image or picture of functional processes in the body. The system detects pairs of gamma rays emitted indirectly by a positron-emitting radionuclide (tracer), which is introduced into the body on a biologically active molecule. Images of tracer concentration in 3-dimensional space within the body are then reconstructed by computer analysis.

Gamma Decay

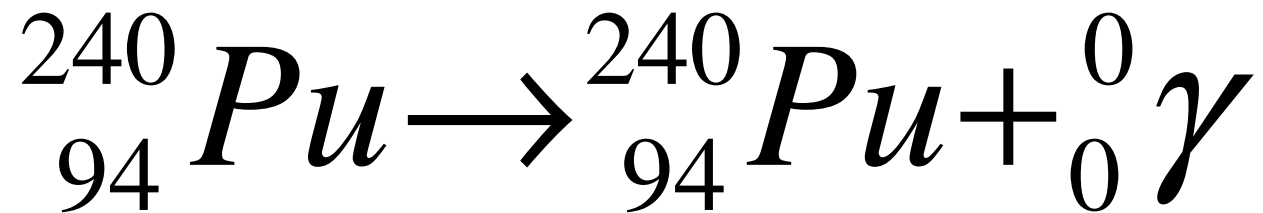
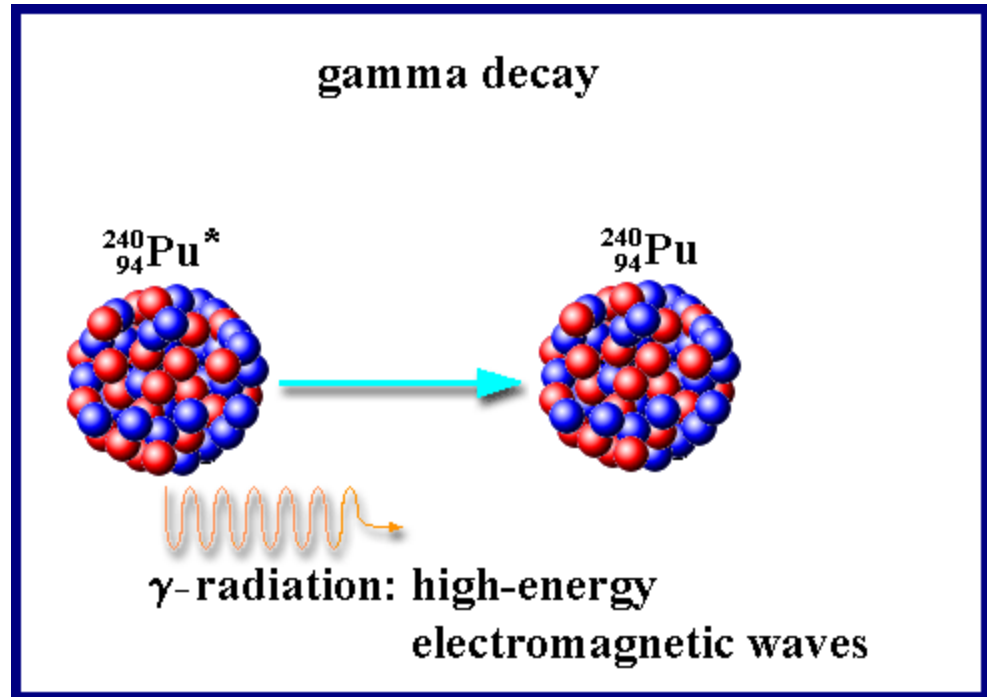

Gamma Decay Applications

Gamma rays are the most dangerous type of radiation as they are very penetrating. They can be used to kill living organisms and sterilize medical equipment before use. They can be used in CT Scans and radiation therapy.

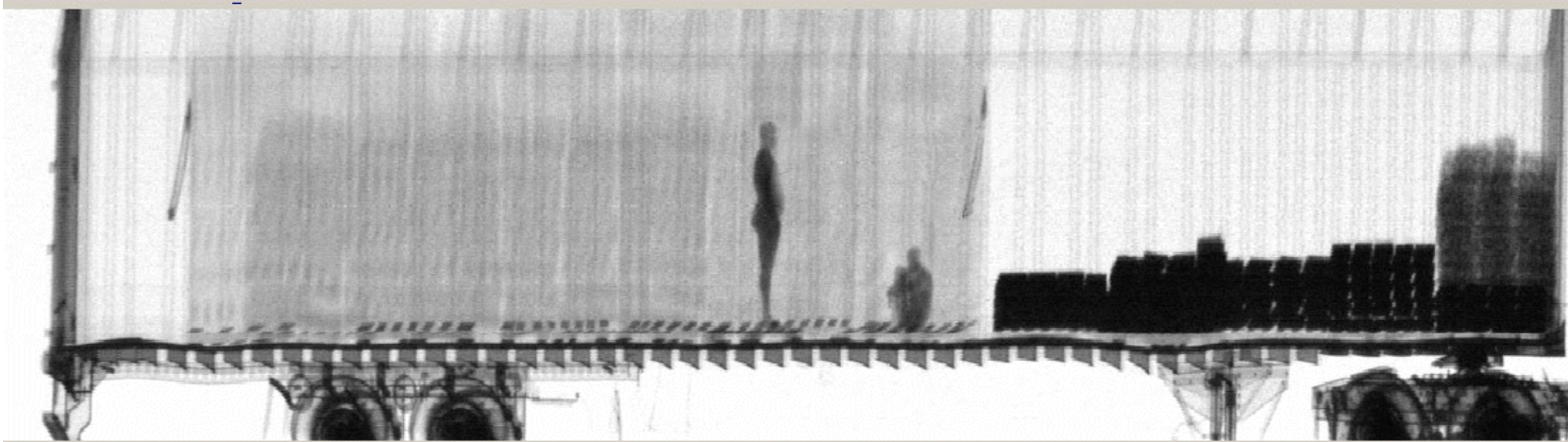

Gamma Rays are used to view stowaways inside of a truck. This technology is used by the Department of Homeland Security at many ports of entry to the US.

Significant Nuclear Reactions - Fusion

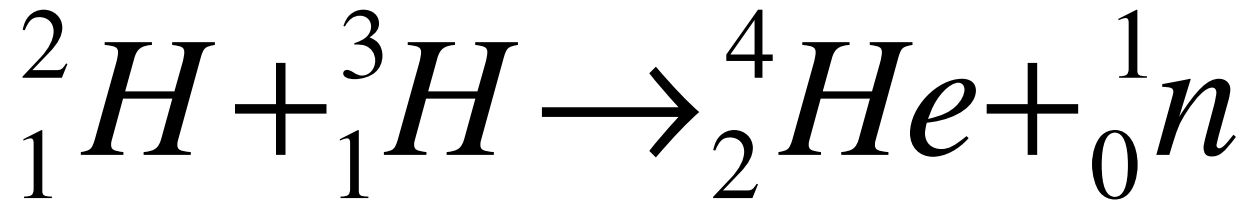
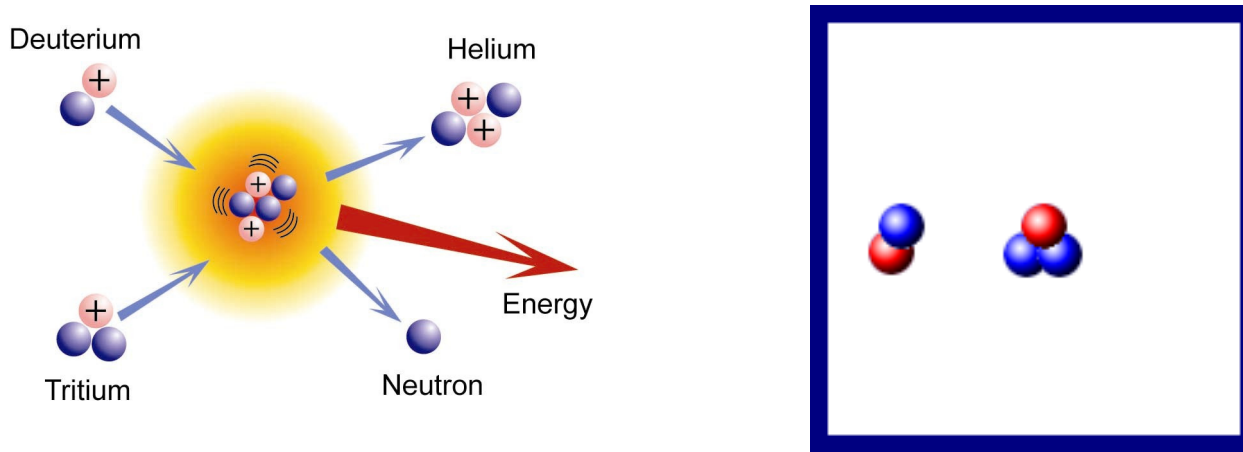

nuclear fusion is the process by which multiple like-charged atomic nuclei join together to form a heavier nucleus. It is accompanied by the release or absorption of energy.

Fusion Applications - IFE

In an IFE (Inertial Fusion Energy) power plant, many (typically **5-10**) pulses of fusion energy per second would heat a low-activation coolant, such as lithium-bearing liquid metals or molten salts, surrounding the fusion targets. The coolant in turn would transfer the fusion heat to a power conversion system to produce electricity.

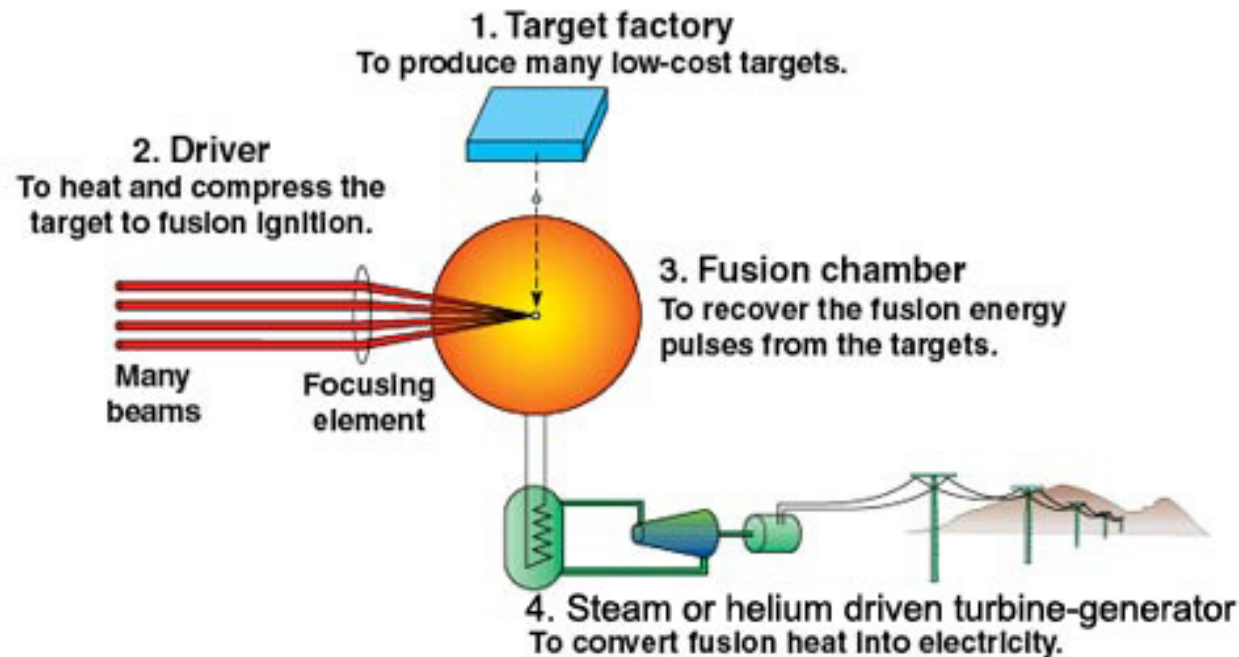

Significant Nuclear Reactions - Fission

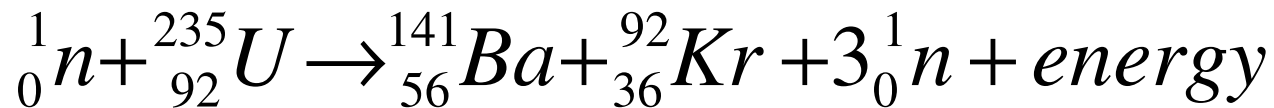
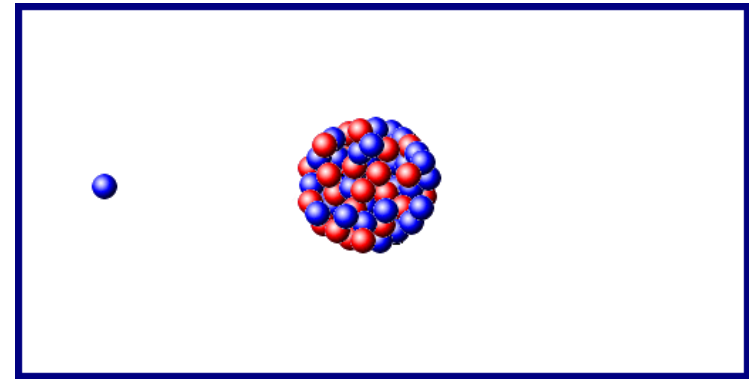
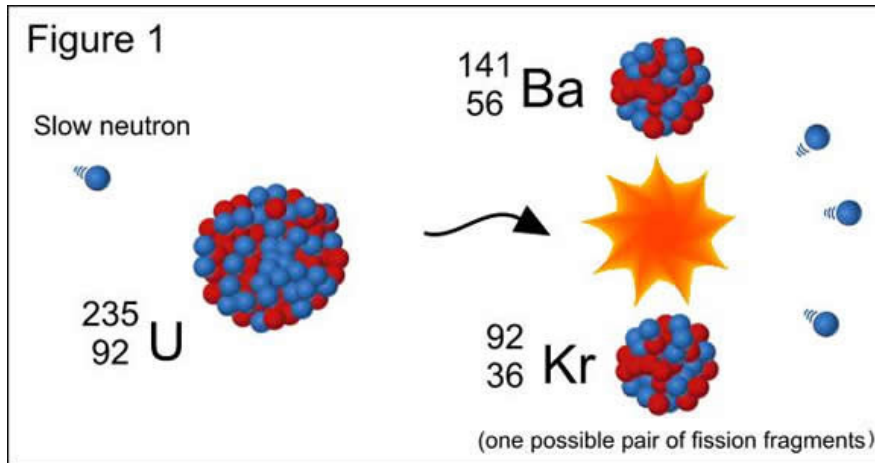

Nuclear fission differs from other forms of radioactive decay in that it can be harnessed and controlled via a chain reaction: free neutrons released by each fission event can trigger yet more events, which in turn release more neutrons and cause more fissions. The most common nuclear fuels are ^{235}U (the isotope of uranium with an atomic mass of 235 and of use in nuclear reactors) and ^{239}Pu (the isotope of plutonium with an atomic mass of 239). These fuels break apart into a bimodal range of chemical elements with atomic masses centering near 95 and 135 u (fission products).

Fission Bomb

One class of nuclear weapon, a *fission bomb* (not to be confused with the *fusion bomb*), otherwise known as an *atomic bomb* or *atom bomb*, is a fission reactor designed to liberate as much energy as possible as rapidly as possible, before the released energy causes the reactor to explode (and the chain reaction to stop).

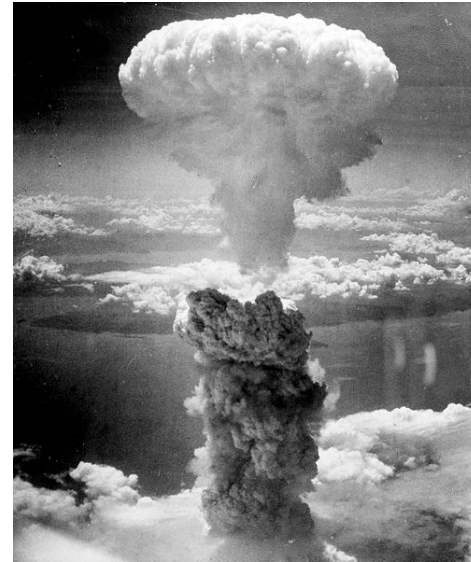

ERROR: stackunderflow
OFFENDING COMMAND: ~

STACK: